



High Performance Cutting Tools



CARBIDE BURRS

CONTENTS

CARBIDE BURR

SERIES	SHAPE DESCRIPTION	TYPE OF SHAPE	TOTEM REFERENCE	PAGE
SA/ZYA	Cylindrical without end cut		C	6.003
SB/ZYAS	Cylindrical with end cut		CE	6.005
SC/WRC	Cylindrical with radius end		B	6.007
SD/KUD	Ball shape		S	6.009
SE/TRE	Oval shape		O	6.011
SF/RBF	Tree shape with radius end		TB	6.012
SG/SPG	Tree shape with point end		T	6.013
SH	Flame shape		F	6.014
SL/KEL	Cone with radius end		K	6.015
SM/SKM	Cone shaped		A	6.017
SN	Inverted cone shape		N	6.019
RIM	RIM shape		R	6.020
-	Burr sets		-	6.021
FL	Flexible carbide burrs		-	6.022

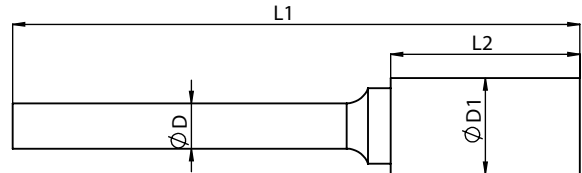
SA
Cylindrical without end cut

3 mm Shank					Standard cut (Single cut)	Supreme cut (Double cut)	Deluxe cut (Diamond cut)	Aluma Cut	Coarse Cut	CTI Number
Head Diameter	Head length	Overall Length	Shank Dia	Tool No	EDP No.	EDP No.	EDP No.	EDP No.	EDP No.	
ØD1	L2	L1	D		EDP No.	EDP No.	EDP No.	EDP No.	EDP No.	
2.8	16	38	3	MC1*	FAC0200563	FAC0200565	FAC0200566	-	-	SA-43M
2.8	16	50	3	MC1L*	FAC0200567	FAC0200568	FAC0200569	-	-	SA-43ML2
2.8	16	75	3	MC1L1*	FAC0200570	FAC0200571	FAC0200572	-	-	SA-43ML3
6.3	6.3	32	3	MC2	FAC0200573	FAC0200574	FAC0200575	-	-	-
6.3	6.3	56	3	MC2L	FAC0200576	FAC0200577	FAC0200578	-	-	-
6.3	6.3	75	3	MC2L1	FAC0200579	FAC0200580	FAC0200581	-	-	-
6.3	12.7	38	3	MC3	FAC0200582	FAC0200583	FAC0200584	-	-	SA-51M
1.5	6	38	3	MC4*	FAC0200585	FAC0200586	FAC0200587	-	-	SA-41M
1.5	6	50	3	MC4L*	FAC0200588	FAC0200589	FAC0200590	-	-	SA-41ML2
1.5	6	75	3	MC4L1*	FAC0200591	FAC0200592	FAC0200593	-	-	SA-41ML3
2.5	11	38	3	MC5*	FAC0200594	FAC0200595	FAC0200596	-	-	SA-42M
2.5	11	50	3	MC5L*	FAC0200597	FAC0200598	FAC0200599	-	-	SA-42ML2
2.5	11	75	3	MC5L1*	FAC0200600	FAC0200601	FAC0200602	-	-	SA-42ML3

6 mm Shank					Standard cut (Single cut)	Supreme cut (Double cut)	Deluxe cut (Diamond cut)	Aluma Cut	Coarse Cut	CTI Number
Head Diameter	Head length	Overall Length	Shank Dia	Tool No	EDP No.	EDP No.	EDP No.	EDP No.	EDP No.	
ØD1	L2	L1	D		EDP No.	EDP No.	EDP No.	EDP No.	EDP No.	
2.8	12.7	50	6	C0	FAC0200208	FAC0200209	FAC0200210	-	-	SA-11M
3.8	14	50	6	C1	FAC0200211	FAC0200212	FAC0200213	-	-	SA-13M
5.8	20	50	6	C2*	FAC0200220	FAC0200221	FAC0200222	-	-	-
6	20	70	6	C2	FAC0200226	FAC0201365	FAC0200227	-	-	-
8	19	69	6	C3	FAC0200236	FAC0200237	FAC0200238	FAC0200245	-	SA-2M
9.5	19	69	6	C4	FAC0200246	FAC0200247	FAC0200249	FAC0200258	-	SA-3M
12.7	19	69	6	C5	FAC0200259	FAC0200263	FAC0200265	FAC0201320	-	-
16	25	75	6	C6	FAC0200273	FAC0200275	FAC0200277	FAC0200279	-	SA-6M
12.7	14	64	6	C7	FAC0200281	FAC0200282	FAC0200283	FAC0200284	-	-
12.7	25	75	6	C8	FAC0200285	FAC0200286	FAC0200287	FAC0200292	-	SA-5M
19	25	75	6	C9	FAC0200294	FAC0200296	FAC0200298	FAC0201314	-	SA-7M
25	25	75	6	C10	FAC0200300	FAC0200302	FAC0200304	FAC0201315	-	SA-9M
5	16	66	6	C11	FAC0200306	FAC0200307	FAC0200308	-	-	SA-14M
6.3	16	66	6	C12	FAC0200309	FAC0200310	FAC0200311	-	-	SA-1M
10	25	75	6	C13	FAC0200312	FAC0200313	FAC0200314	-	-	-
11	25	75	6	C14	FAC0200315	FAC0200316	FAC0200317	-	-	SA-4M

* indicates full carbide burrs

Note:

- Ask your local representative about our long shank program –Available in 4",5",6",7",8",9"10",11" & 12"
- All sizes available as a special in left hand cut
- Coarse cut burrs available on request

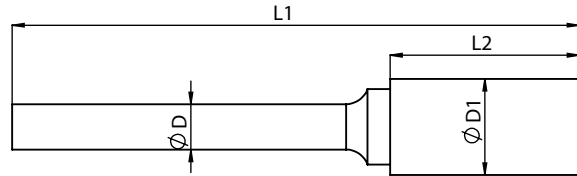
SA
Cylindrical without end cut

8 mm Shank					Tool No	Standard cut (Single cut)	Supreme cut (Double cut)	Deluxe cut (Diamond cut)	Aluma Cut	Coarse Cut	CTI Number
Head Diameter	Head length	Overall Length	Shank Dia	EDP No.		EDP No.	EDP No.	EDP No.	EDP No.		
ØD1	L2	L1	D								
9.5	19	69	8	C4Z	FAC0201858	FAC0200248	FAC0201859	–	–	SA-3M8	
12.7	19	69	8	C5Z	FAC0200261	FAC0200264	FAC0200266	–	–	–	
16	25	75	8	C6Z	FAC0200274	FAC0200276	FAC0200278	–	–	SA-6M8	
19	25	75	8	C9Z	FAC0200295	FAC0200297	FAC0200299	–	–	SA-7M8	
25	25	75	8	C10Z	FAC0200301	FAC0200303	FAC0200305	–	–	SA-9M8	

CARBIDE BURRS

1/8 inch Shank					Tool No	Standard cut (Single cut)	Supreme cut (Double cut)	Deluxe cut (Diamond cut)	Aluma Cut	Coarse Cut	CTI Number
Head Diameter	Head length	Overall Length	Shank Dia	EDP No.		EDP No.	EDP No.	EDP No.	EDP No.		
ØD1	L2	L1	D								
1/16	1/4	1-1/2	1/8	MC4*	FAC0201966	FAC0201968	FAC0201967	–	–	SA-41	
3/32	7/16	1-1/2	1/8	MC5*	FAC0201969	FAC0201971	FAC0201970	–	–	SA-42	
1/8	9/16	1-1/2	1/8	MC1*	FAC0201957	FAC0201959	FAC0201958	–	–	SA-43	
1/4	1/2	2	1/8	MC3I	FAC0201963	FAC0201965	FAC0201964	–	–	SA-51	
1/4	1/4	1-1/2	1/8	MC2I	FAC0201960	FAC0201962	FAC0201961	–	–	–	

1/4 inch Shank					Tool No	Standard cut (Single cut)	Supreme cut (Double cut)	Deluxe cut (Diamond cut)	Aluma Cut	Coarse Cut	CTI Number
Head Diameter	Head length	Overall Length	Shank Dia	EDP No.		EDP No.	EDP No.	EDP No.	EDP No.		
ØD1	L2	L1	D								
1/8	5/8	2	1/4	C1I	FAC0201849	FAC0201851	FAC0201850	–	–	SA-12	
3/16	5/8	2	1/4	C11I	FAC0201840	FAC0201842	FAC0201841	–	–	SA-14	
1/4	5/8	2	1/4	C12I	FAC0201843	FAC0201845	FAC0201844	–	–	SA-1	
5/16	3/4	2-1/2	1/4	C3I	FAC0201852	FAC0201854	FAC0201853	–	–	SA-2	
3/8	3/4	2-1/2	1/4	C4I	FAC0201855	FAC0201857	FAC0201856	–	–	SA-3	
7/16	1	2-3/4	1/4	C14I	FAC0201846	FAC0201848	FAC0201847	–	–	SA-4	
1/2	1	2-3/4	1/4	C8I	FAC0201863	FAC0201865	FAC0201864	–	–	SA-5	
5/8	1	2-3/4	1/4	C6I	FAC0201860	FAC0201862	FAC0201861	–	–	SA-6	
3/4	1	2-3/4	1/4	C9I	FAC0201866	FAC0201868	FAC0201867	–	–	SA-7	
1	1	2-3/4	1/4	C10I	FAC0201837	FAC0201839	FAC0201838	–	–	SA-9	

* indicates full carbide burrs

Note:

- Ask your local representative about our long shank program –Available in 4",5",6",7",8",9",10",11" & 12"
- All sizes available as a special in left hand cut
- Coarse cut burrs available on request

SB

Cylindrical with end cut

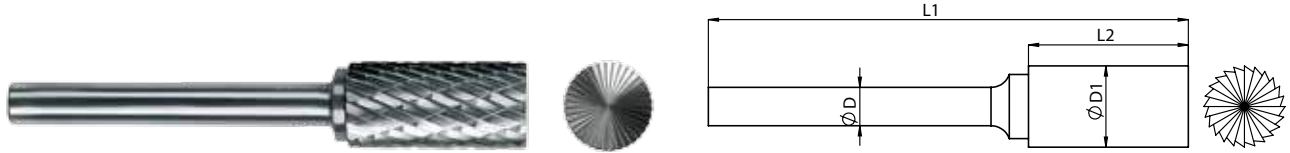

3 mm Shank											
Head Diameter	Head length	Overall Length	Shank Dia	Tool No	Standard cut (Single cut)	Supreme cut (Double cut)	Deluxe cut (Diamond cut)	Aluma Cut	Coarse Cut	CTI Number	
ØD1	L2	L1	D		EDP No.	EDP No.	EDP No.	EDP No.	EDP No.		
2.8	16	38	3	MCE1*	FAC0200603	FAC0200604	FAC0200605	–	–	SB-43M	
2.8	16	50	3	MCE1L*	FAC0200606	FAC0200607	FAC0200608	–	–	SB-43ML2	
2.8	16	75	3	MCE1L1*	FAC0200609	FAC0200610	FAC0200611	–	–	SB-43ML3	
6.3	6.3	32	3	MCE2	FAC0200612	FAC0200613	FAC0200614	–	–	–	
6.3	6.3	56	3	MCE2L	FAC0200615	FAC0200616	FAC0200617	–	–	–	
6.3	6.3	75	3	MCE2L1	FAC0200618	FAC0200619	FAC0200620	–	–	–	
6.3	12.7	38	3	MCE3	FAC0200621	FAC0200622	FAC0200623	–	–	SB-51M	
6.3	16	66	3	CE12	FAC0200391	FAC0200392	FAC0200393	FAC0201339	–	SB-1M	
2.5	11	38	3	MCE5*	FAC0200624	FAC0200625	FAC0200626	–	–	SB-42M	
2.5	11	50	3	MCE5L*	FAC0200627	FAC0200628	FAC0200629	–	–	SB-42ML2	
2.5	11	75	3	MCE5L1*	FAC0200630	FAC0200631	FAC0200632	–	–	SB-42ML3	

6 mm Shank										
Head Diameter	Head length	Overall Length	Shank Dia	Tool No	Standard cut (Single cut)	Supreme cut (Double cut)	Deluxe cut (Diamond cut)	Aluma Cut	Coarse Cut	CTI Number
ØD1	L2	L1	D		EDP No.	EDP No.	EDP No.	EDP No.	EDP No.	
2.8	12.7	50	6	CE0	FAC0200318	FAC0200319	FAC0200320	–	–	SB-11M
3.8	14	50	6	CE1	FAC0200321	FAC0200322	FAC0200323	FAC0201338	–	SB-13M
5.8	20	50	6	CE2*	FAC0200326	FAC0200327	FAC0200328	FAC0201270	–	SB-1M
6	20	70	6	CE2	FAC0200332	FAC0201885	FAC0201884	–	–	SB-1M
8	19	69	6	CE3	FAC0200339	FAC0200340	FAC0200341	FAC0201340	–	SB-2M
9.5	19	69	6	CE4	FAC0200344	FAC0200345	FAC0200346	–	–	SB-3M
12.7	19	69	6	CE5	FAC0200352	FAC0200353	FAC0200355	FAC0201232	–	–
16	25	75	6	CE6	FAC0200356	FAC0200358	FAC0200360	FAC0200362	–	SB-6M
12.7	14	64	6	CE7	FAC0200364	FAC0200365	FAC0200366	FAC0200367	–	–
12.7	25	75	6	CE8	FAC0200368	FAC0200369	FAC0200371	FAC0201342	–	SB-5M
19	25	75	6	CE9	FAC0200376	FAC0200378	FAC0200380	–	–	SB-7M
25	25	75	6	CE10	FAC0200382	FAC0200384	FAC0200386	–	–	–
5	16	66	6	CE11	FAC0200388	FAC0200389	FAC0200390	–	–	SB-14M
10	25	75	6	CE13	FAC0200394	FAC0200395	FAC0200396	FAC0201341	–	–
11	25	75	6	CE14	FAC0200397	FAC0200398	FAC0200399	–	–	SB-4M

* indicates full carbide burrs

Note:

- Ask your local representative about our long shank program –Available in 4",5",6",7",8",9"10",11" & 12"
- All sizes available as a special in left hand cut
- Coarse cut burrs available on request

SB

Cylindrical with end cut

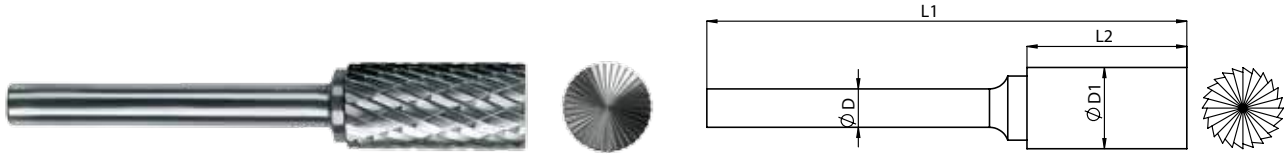

8 mm Shank					Tool No	Standard cut (Single cut)	Supreme cut (Double cut)	Deluxe cut (Diamond cut)	Aluma Cut	Coarse Cut	CTI Number
Head Diameter	Head length	Overall Length	Shank Dia	EDP No.		EDP No.	EDP No.	EDP No.	EDP No.		
ØD1	L2	L1	D								
9.5	19	69	8	CE4Z	FAC0201892	FAC0201278	FAC0201893	–	–	SB-3M8	
12.7	19	69	8	CE5Z	FAC0201894	FAC0200354	–	–	–	–	
12.7	25	75	8	CE8Z	FAC0201901	FAC0200370	FAC0201293	–	–	SB-5M8	
19	25	75	8	CE9Z	FAC0200377	FAC0200379	FAC0200381	–	–	SB-7M8	
16	25	75	8	CE6Z	FAC0200357	FAC0200359	FAC0200361	–	–	SB-6M8	
25	25	75	8	CE10Z	FAC0200383	FAC0200385	FAC0200387	–	–	–	

1/8 inch Shank					Tool No	Standard cut (Single cut)	Supreme cut (Double cut)	Deluxe cut (Diamond cut)	Aluma Cut	Coarse Cut	CTI Number
Head Diameter	Head length	Overall Length	Shank Dia	EDP No.		EDP No.	EDP No.	EDP No.	EDP No.		
ØD1	L2	L1	D								
3/32	7/16	1-1/2	1/8	MCE51*	FAC0201978	FAC0201980	FAC0201979	–	–	SB-42	
1/8	9/16	1-1/2	1/8	MCE11*	FAC0201975	FAC0201977	FAC0201976	–	–	SB-43	
1/4	5/8	2-5/8	1/8	MCE12I	FAC0201972	FAC0201974	FAC0201973	–	–	SB-51	

1/4 inch Shank					Tool No	Standard cut (Single cut)	Supreme cut (Double cut)	Deluxe cut (Diamond cut)	Aluma Cut	Coarse Cut	CTI Number
Head Diameter	Head length	Overall Length	Shank Dia	EDP No.		EDP No.	EDP No.	EDP No.	EDP No.		
ØD1	L2	L1	D								
1/8	5/8	2	1/4	CE0I	FAC0201869	FAC0201871	FAC0201870	–	–	SB-12	
3/16	5/8	2-5/8	1/4	CE11I	FAC0201875	FAC0201877	FAC0201876	–	–	SB-14	
1/4	5/8	2-5/8	1/4	CE12I	FAC0201878	FAC0201880	FAC0201879	–	–	SB-1	
5/16	3/4	2-3/4	1/4	CE3I	FAC0201886	FAC0201888	FAC0201887	–	–	SB-2	
3/8	3/4	2-3/4	1/4	CE4I	FAC0201889	FAC0201891	FAC0201890	–	–	SB-3	
7/16	1	3	1/4	CE14I	FAC0201881	FAC0201883	FAC0201882	–	–	SB-4	
1/2	1	3	1/4	CE8I	FAC0201898	FAC0201900	FAC0201899	–	–	SB-5	
5/8	1	3	1/4	CE6I	FAC0201895	FAC0201897	FAC0201896	–	–	SB-6	
3/4	1	3	1/4	CE9I	FAC0201902	FAC0201904	FAC0201903	–	–	SB-7	
1	1	3	1/4	CE10I	FAC0201872	FAC0201874	FAC0201873	–	–	SB-9	

* indicates full carbide burrs

Note:

- Ask your local representative about our long shank program –Available in 4", 5", 6", 7", 8", 9", 10", 11" & 12"
- All sizes available as a special in left hand cut
- Coarse cut burrs available on request

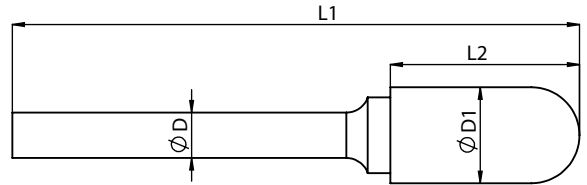
SC
Cylindrical with radius end

3 mm Shank					Standard cut (Single cut)	Supreme cut (Double cut)	Deluxe cut (Diamond cut)	Aluma Cut	Coarse Cut	CTI Number
Head Diameter	Head length	Overall Length	Shank Dia	Tool No	EDP No.	EDP No.	EDP No.	EDP No.	EDP No.	
$\varnothing D1$	L2	L1	D		EDP No.	EDP No.	EDP No.	EDP No.	EDP No.	
2.5	11	38	3	MB0*	FAC0200542	FAC0200543	FAC0200544	–	–	SC-41M
2.8	16	38	3	MB1*	FAC0200545	FAC0200547	FAC0200548	–	–	SC-42M
2.8	16	50	3	MB1L*	FAC0200549	FAC0200550	FAC0200551	–	–	SC-42ML2
2.8	16	75	3	MB1L1*	FAC0200552	FAC0200553	FAC0200554	–	–	SC-43ML3
6.3	12.7	38	3	MB2	FAC0200556	FAC0200557	FAC0200558	–	–	SC-51
6.3	12.7	63	3	MB2L	FAC0200559	FAC0200560	FAC0200561	–	–	SC-51L2

6 mm Shank					Standard cut (Single cut)	Supreme cut (Double cut)	Deluxe cut (Diamond cut)	Aluma Cut	Coarse Cut	CTI Number
Head Diameter	Head length	Overall Length	Shank Dia	Tool No	EDP No.	EDP No.	EDP No.	EDP No.	EDP No.	
$\varnothing D1$	L2	L1	D		EDP No.	EDP No.	EDP No.	EDP No.	EDP No.	
2.8	16	69	6	B0	FAC0200074	FAC0200075	FAC0200076	–	–	SC-12M
2.8	20	50	6	B1*	FAC0200077	FAC0200078	FAC0200079	–	–	–
6	20	70	6	B1	FAC0200083	FAC0201707	FAC0201219	–	–	–
8	19	69	6	B2	FAC0200097	FAC0200099	FAC0200101	FAC0200112	–	SC-2M
9.5	19	69	6	B3	FAC0200113	FAC0200115	FAC0200117	FAC0200131	–	SC-3M
12.7	19	69	6	B4	FAC0200132	FAC0200134	FAC0200136	FAC0200144	–	–
16	25	75	6	B5	FAC0200145	FAC0200147	FAC0200149	FAC0200155	–	SC-6M
12.7	25	75	6	B6	FAC0200157	FAC0200159	FAC0200161	FAC0200173	–	SC-5M
4	19	55	6	B7	FAC0200175	FAC0200176	FAC0200177	–	–	SC-13M
5	19	70	6	B8	FAC0200178	FAC0200179	FAC0200180	–	–	SC-14M
19	25	75	6	B9	FAC0200181	FAC0200183	FAC0200185	FAC0200187	–	SC-7M
25	25	75	6	B10	FAC0200189	FAC0200191	FAC0200193	FAC0200195	–	SC-9M
6.3	16	66	6	B11	FAC0200197	FAC0200198	FAC0200199	–	–	SC-1M
10	25	75	6	B12	FAC0200200	FAC0200201	FAC0200202	FAC0200203	–	SC-3MZ
11	25	75	6	B13	FAC0200204	FAC0200205	FAC0200206	FAC0200207	–	SC-4M

* indicates full carbide burrs

Note:

- Ask your local representative about our long shank program –Available in 4",5",6",7",8",9",10",11" & 12"
- All sizes available as a special in left hand cut
- Coarse cut burrs available on request

SC

Cylindrical with radius end

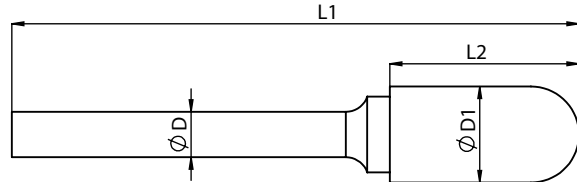

8 mm Shank					Tool No	Standard cut (Single cut) EDP No.	Supreme cut (Double cut) EDP No.	Deluxe cut (Diamond cut) EDP No.	Aluma Cut EDP No.	Coarse Cut EDP No.	CTI Number
Head Diameter Ø D1	Head length L2	Overall Length L1	Shank Dia D								
8	19	69	8	B2Z							
9.5	19	69	8	B3Z	FAC0200114	FAC0200116	FAC0201823	-	-	SC-3M8	
12.7	19	69	8	B4Z	FAC0200133	FAC0200135	FAC0200137	-	-	-	
16	25	75	8	B5Z	FAC0200146	FAC0200148	FAC0200150	FAC0200156	-	SC-6M8	
12.7	25	75	8	B6Z	FAC0200158	FAC0200160	FAC0201830	FAC0200174	-	SC-5M8	
19	25	75	8	B9Z	FAC0200182	FAC0200184	FAC0200186	FAC0200188	-	SC-7M8	
25	25	75	8	B10Z	FAC0200190	FAC0200192	FAC0200194	FAC0200196	-	SC-9M8	

1/8 inch Shank					Tool No	Standard cut (Single cut) EDP No.	Supreme cut (Double cut) EDP No.	Deluxe cut (Diamond cut) EDP No.	Aluma Cut EDP No.	Coarse Cut EDP No.	CTI Number
Head Diameter Ø D1	Head length L2	Overall Length L1	Shank Dia D								
3/32	7/16	1-1/2	1/8	MB0I*							
1/8	9/16	1-1/2	1/8	MB1I*	FAC0201951	FAC0201953	FAC0201952	-	-	SC-42	
1/4	1/2	1-1/2	1/8	MB2I	FAC0201954	FAC0201956	FAC0201955	-	-	SC-51	

1/4 inch Shank					Tool No	Standard cut (Single cut) EDP No.	Supreme cut (Double cut) EDP No.	Deluxe cut (Diamond cut) EDP No.	Aluma Cut EDP No.	Coarse Cut EDP No.	CTI Number
Head Diameter Ø D1	Head length L2	Overall Length L1	Shank Dia D								
1/8	5/8	2-5/8	1/4	B0I							
3/16	3/4	2-3/4	1/4	B8I	FAC0201831	FAC0201833	FAC0201832	-	-	SC-14	
1/4	5/8	2-5/8	1/4	B11I	FAC0201810	FAC0201812	FAC0201811	-	-	SC-1	
5/16	3/4	2-3/4	1/4	B2I	FAC0201816	FAC0201818	FAC0201817	-	-	SC-2	
3/8	3/4	2-3/4	1/4	B3I	FAC0201820	FAC0201822	FAC0201821	-	-	SC-3	
7/16	1	3	1/4	B13I	FAC0201813	FAC0201815	FAC0201814	-	-	SC-4	
1/2	1	3	1/4	B6I	FAC0201827	FAC0201829	FAC0201828	-	-	SC-5	
5/8	1	3	1/4	B5I	FAC0201824	FAC0201826	FAC0201825	-	-	SC-6	
3/4	1	3	1/4	B9I	FAC0201834	FAC0201836	FAC0201835	-	-	SC-7	

* indicates full carbide burrs

Note:

- Ask your local representative about our long shank program –Available in 4",5",6",7",8",9",10",11" & 12"
- All sizes available as a special in left hand cut
- Coarse cut burrs available on request

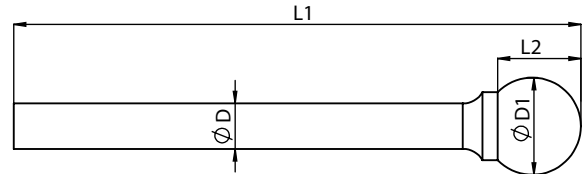
SD
Ball shape

3 mm Shank					Standard cut (Single cut)	Supreme cut (Double cut)	Deluxe cut (Diamond cut)	Aluma Cut	Coarse Cut	CTI Number
Head Diameter	Head length	Overall Length	Shank Dia	Tool No	EDP No.	EDP No.	EDP No.	EDP No.	EDP No.	
ØD1	L2	L1	D							
2.5	2.3	38	3	MS2*	FAC0200691	FAC0200692	FAC0200693	–	–	SD-41M
2.8	2.5	38	3	MS0*	FAC0200678	FAC0200679	FAC0200680	–	–	SD-42M
2.8	2.5	50	3	MSOL*	FAC0200681	FAC0200682	FAC0200683	–	–	SD-42ML2
2.8	2.5	75	3	MSOL1*	FAC0200684	FAC0200685	FAC0200686	–	–	SD-42ML3
2.8	3	75	3	MS3*	FAC0201249	FAC0201250	FAC0201251	–	–	–
4	3.4	38	3	MS1*	FAC0200687	FAC0200689	FAC0200690	–	–	SD-52M

6 mm Shank										
Head Diameter	Head length	Overall Length	Shank Dia	Tool No	Standard cut (Single cut)	Supreme cut (Double cut)	Deluxe cut (Diamond cut)	Aluma Cut	Coarse Cut	CTI Number
ØD1	L2	L1	D		EDP No.	EDP No.	EDP No.	EDP No.	EDP No.	
6.3	6.3	50	6	S1*	FAC0200805	FAC0200806	FAC0200807	FAC0201351	–	SD-1M
6.3	6.3	56	6	S1	FAC0201332	FAC0201333	FAC0201334	–	–	–
8	6.4	50	6	S2*	FAC0200814	FAC0200815	FAC0200817	–	–	SD-2M
8	6.4	56	6	S2	FAC0200818	–	–	–	–	–
9.5	8	58	6	S3	FAC0200824	FAC0200826	FAC0200828	FAC0200836	–	SD-3M
12.7	11	61	6	S4	FAC0200838	FAC0200840	FAC0200842	FAC0200852	–	SD-5M
16	14	64	6	S5	FAC0200854	FAC0200856	FAC0200858	FAC0200864	–	SD-6M
19	16	66	6	S6	FAC0200867	FAC0200869	FAC0200871	FAC0200873	–	SD-7M
25	21	71	6	S7	FAC0200875	FAC0200877	FAC0200879	FAC0200881	–	SD-9M
11	9.5	60	6	S9	FAC0200883	FAC0200884	FAC0200885	FAC0200886	–	SD-4M

* indicates full carbide burrs

Note:

- Ask your local representative about our long shank program –Available in 4",5",6",7",8",9"10",11"& 12"
- All sizes available as a special in left hand cut
- Coarse cut burrs available on request

SD

Ball shape

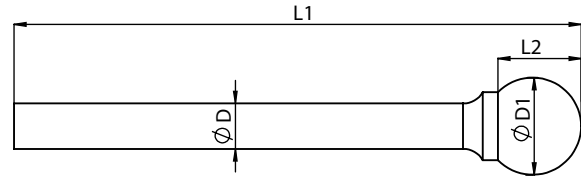

8 mm Shank					Tool No	Standard cut (Single cut) EDP No.	Supreme cut (Double cut) EDP No.	Deluxe cut (Diamond cut) EDP No.	Aluma Cut EDP No.	Coarse Cut EDP No.	CTI Number
Head Diameter	Head length	Overall Length	Shank Dia								
Ø D1	L2	L1	D								
8	6.4	56	8	S2Z	FAC0202038	FAC0200816	FAC0202038	-	-	SD-2M8	
9.5	8	58	8	S3Z	FAC0200825	FAC0200827	FAC0202042	-	-	SD-3M8	
12.7	11	61	8	S4Z	FAC0200839	FAC0200841	FAC0200843	-	-	SD-5M8	
16	14	64	8	S5Z	FAC0200855	FAC0200857	FAC0200859	FAC0200865	-	SD-6M8	
19	16	66	8	S6Z	FAC0200868	FAC0200870	FAC0200872	FAC0200874	-	SD-7M8	
25	21	71	8	S7Z	FAC0200876	FAC0200878	FAC0200880	FAC0200882	-	SD-9M8	

1/8 inch Shank					Tool No	Standard cut (Single cut) EDP No.	Supreme cut (Double cut) EDP No.	Deluxe cut (Diamond cut) EDP No.	Aluma Cut EDP No.	Coarse Cut EDP No.	CTI Number
Head Diameter	Head length	Overall Length	Shank Dia								
3/32	3/32	1-1/2	1/8								
3/32	3/32	1-1/2	1/8	MS2I*	FAC0201999	FAC0202001	FAC0202000	-	-	SD-41	
1/8	1/8	1-1/2	1/8	MS0I*	FAC0201996	FAC0201998	FAC0201997	-	-	SD-42	

1/4 inch Shank					Tool No	Standard cut (Single cut) EDP No.	Supreme cut (Double cut) EDP No.	Deluxe cut (Diamond cut) EDP No.	Aluma Cut EDP No.	Coarse Cut EDP No.	CTI Number
Head Diameter	Head length	Overall Length	Shank Dia								
1/4	7/32	2	1/4								
1/4	7/32	2	1/4	S1I	FAC0202032	FAC0202034	FAC0202033	-	-	SD-1	
5/16	1/4	2	1/4	S2I	FAC0202035	FAC0202037	FAC0202036	-	-	SD-2	
3/8	5/16	2-5/16	1/4	S3I	FAC0202039	FAC0202041	FAC0202040	-	-	SD-3	
1/2	7/16	2-7/16	1/4	S4I	FAC0202043	FAC0202045	FAC0202044	-	-	SD-5	
5/8	9/16	2-9/16	1/4	S5I	FAC0202046	FAC0202048	FAC0202047	-	-	SD-6	
3/4	5/8	2-5/8	1/4	S6I	FAC0202049	FAC0202051	FAC0202050	-	-	SD-7	
1	15/16	2-15/16	1/4	S7I	FAC0202052	FAC0202054	FAC0202053	-	-	SD-9	
7/16	3/8	2-3/8	1/4	S9I	FAC0202056	FAC0202058	FAC0202057	-	-	SD-4	

* indicates full carbide burrs

Note:

- Ask your local representative about our long shank program – Available in 4", 5", 6", 7", 8", 9", 10", 11" & 12"
- All sizes available as a special in left hand cut
- Coarse cut burrs available on request

SE
Oval shape

3 mm Shank					Standard cut (Single cut)	Supreme cut (Double cut)	Deluxe cut (Diamond cut)	Aluma Cut	Coarse Cut	CTI Number
Head Diameter	Head length	Overall Length	Shank Dia	Tool No	EDP No.	EDP No.	EDP No.	EDP No.	EDP No.	
ØD1	L2	L1	D							
2.8	8	38	3	M01*	FAC0200659	FAC0200660	FAC0200661	–	–	SE-41M
2.8	8	50	3	M01L*	FAC0200662	FAC0200663	FAC0200664	–	–	SE-41ML2
2.8	8	75	3	M01L1*	FAC0200665	FAC0200666	FAC0200667	–	–	SE-41ML3
6.3	9.5	38	3	M02*	FAC0200668	FAC0200669	FAC0200670	–	–	SE-51M
6.3	9.5	50	3	M02L*	FAC0200671	FAC0200672	FAC0200673	–	–	SE-51ML2
6.3	9.5	75	3	M02L1*	FAC0200674	FAC0200675	FAC0200676	–	–	SE-51ML3

6 mm Shank					Standard cut (Single cut)	Supreme cut (Double cut)	Deluxe cut (Diamond cut)	Aluma Cut	Coarse Cut	CTI Number
Head Diameter	Head length	Overall Length	Shank Dia	Tool No	EDP No.	EDP No.	EDP No.	EDP No.	EDP No.	
ØD1	L2	L1	D							
8	12	51	6	O1*	FAC0200726	FAC0200727	FAC0200728	FAC0200734	–	SE-2M
12.7	19	69	6	O2	FAC0200735	FAC0200737	FAC0200739	FAC0200746	–	–
16	25	75	6	O3	FAC0200747	FAC0200749	FAC0200751	FAC0200754	–	SE-6M
6.3	10	51	6	O4*	FAC0200755	FAC0200756	FAC0200757	–	–	SE-1M
9.5	16	65	6	O5	FAC0200762	FAC0200763	FAC0200764	FAC0200768	–	SE-3M
12.7	22	72	6	O6	FAC0200770	FAC0200771	FAC0200772	FAC0200776	–	SE-5M
19	25	75	6	O7	FAC0200778	FAC0200780	FAC0200782	FAC0200784	–	SE-7M

8 mm Shank					Standard cut (Single cut)	Supreme cut (Double cut)	Deluxe cut (Diamond cut)	Aluma Cut	Coarse Cut	CTI Number
Head Diameter	Head length	Overall Length	Shank Dia	Tool No	EDP No.	EDP No.	EDP No.	EDP No.	EDP No.	
ØD1	L2	L1	D							
12.7	19	69	8	O2Z	FAC0200736	FAC0200738	FAC0200740	–	–	–
16	25	75	8	O3Z	FAC0200748	FAC0200750	FAC0200752	–	–	SE-6M8
9.5	16	66	8	O5Z	FAC0202024	FAC0201269	FAC0202025	–	–	SE-3M8
19	25	75	8	O7Z	FAC0200779	FAC0200781	FAC0200783	–	–	SE-7M8

1/8 inch Shank					Standard cut (Single cut)	Supreme cut (Double cut)	Deluxe cut (Diamond cut)	Aluma Cut	Coarse Cut	CTI Number
Head Diameter	Head length	Overall Length	Shank Dia	Tool No	EDP No.	EDP No.	EDP No.	EDP No.	EDP No.	
ØD1	L2	L1	D							
1/8	5/16	1-1/2	1/8	M01*	FAC0201990	FAC0201992	FAC0201991	–	–	SE-41
1/4	3/8	1-1/2	1/8	M02*	FAC0201993	FAC0201995	FAC0201994	–	–	SE-51

1/4 inch Shank					Standard cut (Single cut)	Supreme cut (Double cut)	Deluxe cut (Diamond cut)	Aluma Cut	Coarse Cut	CTI Number
Head Diameter	Head length	Overall Length	Shank Dia	Tool No	EDP No.	EDP No.	EDP No.	EDP No.	EDP No.	
ØD1	L2	L1	D							
5/8	1	3	1/4	O3I	FAC0202015	FAC0202017	FAC0202016	–	–	SE-6
1/4	3/8	2-3/8	1/4	O4I	FAC0202018	FAC0202020	FAC0202019	–	–	SE-1
3/8	5/8	2-5/8	1/4	O5I	FAC0202021	FAC0202023	FAC0202022	–	–	SE-3
1/2	3/4	2-3/4	1/4	O6I	FAC0202026	FAC0202028	FAC0202027	–	–	SE-5
3/4	1	3	1/4	O7I	FAC0202029	FAC0202031	FAC0202030	–	–	SE-7S

* indicates full carbide burrs

Note:

- Ask your local representative about our long shank program –Available in 4",5",6",7",8",9"10",11" & 12"
- All sizes available as a special in left hand cut
- Coarse cut burrs available on request

SF

Tree shape with radius end

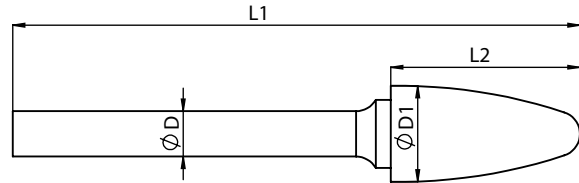

3 mm Shank					Standard cut (Single cut)	Supreme cut (Double cut)	Deluxe cut (Diamond cut)	Aluma Cut	Coarse Cut	CTI Number
Head Diameter	Head length	Overall Length	Shank Dia	Tool No	EDP No.	EDP No.	EDP No.	EDP No.	EDP No.	
ØD1	L2	L1	D							
2.8	6	38	3	MTB1*	FAC0200714	FAC0200715	FAC0200716	-	-	SF-41M
2.8	12.7	38	3	MTB2*	FAC0200717	FAC0200718	FAC0200719	-	-	SF-42M
2.8	12.7	50	3	MTB2L*	FAC0200720	FAC0200721	FAC0200722	-	-	-
2.8	12.7	75	3	MTB2L1*	FAC0200723	FAC0200724	FAC0200725	-	-	-

6 mm Shank					Standard cut (Single cut)	Supreme cut (Double cut)	Deluxe cut (Diamond cut)	Aluma Cut	Coarse Cut	CTI Number
Head Diameter	Head length	Overall Length	Shank Dia	Tool No	EDP No.	EDP No.	EDP No.	EDP No.	EDP No.	
6	19	69	6	TB1	FAC0200962	FAC0200963	FAC0200964	-	-	SF-1M
9.5	19	69	6	TB2	FAC0200971	FAC0200973	FAC0200975	FAC0200986	-	SF-3M
12.7	25	75	6	TB3	FAC0200988	FAC0200990	FAC0200992	FAC0201002	-	SF-5M
16	32	82	6	TB4	FAC0201004	FAC0201006	FAC0201008	-	-	-
8	19	69	6	TB5	FAC0201011	FAC0201012	FAC0201013	FAC0201345	-	SF-2M
6.3	16	66	6	TB6	FAC0201014	FAC0201015	FAC0201016	-	-	SF-1M
11	25	75	6	TB7	FAC0201017	FAC0201018	FAC0201020	FAC0201021	-	SF-4M
16	32	82	6	TB8	FAC0201022	FAC0201024	FAC0201026	FAC0201028	-	SF-6M
19	25	75	6	TB9	FAC0201030	FAC0201032	FAC0201034	FAC0201036	-	SF-7M

8 mm Shank					Standard cut (Single cut)	Supreme cut (Double cut)	Deluxe cut (Diamond cut)	Aluma Cut	Coarse Cut	CTI Number
Head Diameter	Head length	Overall Length	Shank Dia	Tool No	EDP No.	EDP No.	EDP No.	EDP No.	EDP No.	
9.5	19	69	8	TB2Z	FAC0200972	FAC0200974	FAC0200976	-	-	-
12.7	25	75	8	TB3Z	FAC0200989	FAC0200991	FAC0200993	FAC0201288	-	-
16	32	82	8	TB4Z	FAC0201005	FAC0201007	FAC0201009	FAC0201010	-	-
16	32	82	8	TB8Z	FAC0201023	FAC0201025	FAC0201027	FAC0201029	-	SF-6M8
19	25	75	8	TB9Z	FAC0201031	FAC0201033	FAC0201035	FAC0201037	-	SF-7M8

1/8 inch Shank					Standard cut (Single cut)	Supreme cut (Double cut)	Deluxe cut (Diamond cut)	Aluma Cut	Coarse Cut	CTI Number
Head Diameter	Head length	Overall Length	Shank Dia	Tool No	EDP No.	EDP No.	EDP No.	EDP No.	EDP No.	
1/8	1/4	1-1/2	1/8	MTB1*	FAC0202002	FAC0202004	FAC0202003	-	-	SF-41
1/8	1/2	1-1/2	1/8	MTB2*	FAC0202005	FAC0202007	FAC0202006	-	-	SF-42

1/4 inch Shank					Standard cut (Single cut)	Supreme cut (Double cut)	Deluxe cut (Diamond cut)	Aluma Cut	Coarse Cut	CTI Number
Head Diameter	Head length	Overall Length	Shank Dia	Tool No	EDP No.	EDP No.	EDP No.	EDP No.	EDP No.	
1/4	5/8	2-5/8	1/4	TB1I	FAC0202078	FAC0202080	FAC0202079	-	-	SF-1
3/8	3/4	2-3/4	1/4	TB2I	FAC0202081	FAC0202083	FAC0202082	-	-	SF-3
7/16	1	3	1/4	TB7I	FAC0202087	FAC0202089	FAC0202088	-	-	SF-4
1/2	1	3	1/4	TB3I	FAC0202084	FAC0202086	FAC0202085	-	-	SF-5
5/8	1	3	1/4	TB8I	FAC0202090	FAC0202092	FAC0202091	-	-	SF-6
3/4	1	3	1/4	TB9I	FAC0202093	FAC0202095	FAC0202094	-	-	SF-7

* indicates full carbide burrs

Note:

- Ask your local representative about our long shank program –Available in 4", 5", 6", 7", 8", 9", 10", 11" & 12"
- All sizes available as a special in left hand cut
- Coarse cut burrs available on request

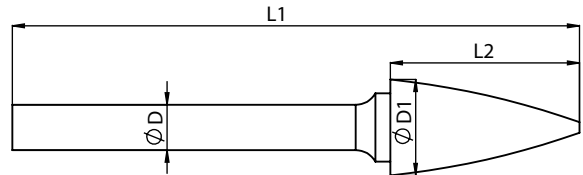
SG
Tree shape with point end

3 mm Shank					Tool No	Standard cut (Single cut)	Supreme cut (Double cut)	Deluxe cut (Diamond cut)	Aluma Cut	Coarse Cut	CTI Number
Head Diameter	Head length	Overall Length	Shank Dia	EDP No.		EDP No.	EDP No.	EDP No.	EDP No.		
ØD1	L2	L1	D								
3	16	38	3	MT1*	FAC0200694	FAC0200697	FAC0200698	–	–	SG-41M	
2.8	16	38	3	MT2*	FAC0200700	FAC0200701	FAC0200703	–	–	–	
6.3	10	36	3	MT3	FAC0200704	FAC0200705	FAC0200706	–	–	SG-51M	
2.8	12.7	38	3	MT4*	FAC0200708	FAC0200709	FAC0200710	–	–	–	
3	6	38	3	MT5*	FAC0200711	FAC0200712	FAC0200713	–	–	SG-44M	
3	8	75	3	MT6*	FAC0201252	FAC0201253	FAC0200254	–	–	SG-41M	

6 mm Shank					Tool No	Standard cut (Single cut)	Supreme cut (Double cut)	Deluxe cut (Diamond cut)	Aluma Cut	Coarse Cut	CTI Number
Head Diameter	Head length	Overall Length	Shank Dia	EDP No.		EDP No.	EDP No.	EDP No.	EDP No.		
ØD1	L2	L1	D								
6	19	50	6	T1*	FAC0200887	FAC0200888	FAC0200889	–	–	SG-1M	
6	19	70	6	T1	FAC0200891	FAC0202062	FAC0200892	–	–	SG-1M	
9.5	19	69	6	T2	FAC0200902	FAC0200903	FAC0200905	FAC0201347	–	SG-3M	
12.7	25	75	6	T3	FAC0200915	FAC0200920	FAC0200922	–	–	SG-5M	
16	32	82	6	T4	FAC0200932	FAC0200934	FAC0200936	–	–	SG-6M	
8	19	69	6	T5	FAC0200941	FAC0200942	FAC0200943	FAC0201346	–	SG-2M	
16	25	75	6	T6	FAC0200947	FAC0200949	FAC0200951	–	–	–	
6.3	16	66	6	T7	FAC0200953	FAC0200954	FAC0200955	–	–	SG-1M	
19	25	75	6	T8	FAC0200956	FAC0200958	FAC0200960	–	–	SG-7M	

8 mm Shank					Tool No	Standard cut (Single cut)	Supreme cut (Double cut)	Deluxe cut (Diamond cut)	Aluma Cut	Coarse Cut	CTI Number
Head Diameter	Head length	Overall Length	Shank Dia	EDP No.		EDP No.	EDP No.	EDP No.	EDP No.		
ØD1	L2	L1	D								
9.5	19	69	8	T2Z	FAC0202096	FAC0200904	FAC0202097	–	–	–	
12.7	25	75	8	T3Z	FAC0200916	FAC0200921	FAC0201294	–	–	–	
16	32	82	8	T4Z	FAC0200933	FAC0200935	FAC0200935	–	–	SG-6ML8	
16	25	75	8	T6Z	FAC0200948	FAC0200950	FAC0200952	–	–	–	
19	25	75	8	T8Z	FAC0200957	FAC0200959	FAC0200961	–	–	SG-7M8	

1/8 inch Shank					Tool No	Standard cut (Single cut)	Supreme cut (Double cut)	Deluxe cut (Diamond cut)	Aluma Cut	Coarse Cut	CTI Number
Head Diameter	Head length	Overall Length	Shank Dia	EDP No.		EDP No.	EDP No.	EDP No.	EDP No.		
ØD1	L2	L1	D								
1/8	1/4	1-1/2	1/8	MT5I*	FAC0202098	FAC0202100	FAC0202099	–	–	SG-44	
1/8	1/2	1-1/2	1/8	MT4I*	FAC0202101	FAC0202103	FAC0202102	–	–	SG-41	

1/4 inch Shank					Tool No	Standard cut (Single cut)	Supreme cut (Double cut)	Deluxe cut (Diamond cut)	Aluma Cut	Coarse Cut	CTI Number
Head Diameter	Head length	Overall Length	Shank Dia	EDP No.		EDP No.	EDP No.	EDP No.	EDP No.		
ØD1	L2	L1	D								
1/4	3/4	2-3/4	1/4	T1I	FAC0202059	FAC0202061	FAC0202060	–	–	SG-1	
5/16	3/4	2-3/4	1/4	T5I	FAC0202069	FAC0202071	FAC0202070	–	–	SG-2	
3/8	3/4	2-3/4	1/4	T2I	FAC0202063	FAC0202065	FAC0202064	–	–	SG-3	
1/2	1	3	1/4	T3I	FAC0202066	FAC0202068	FAC0202067	–	–	SG-5	
5/8	1	3	1/4	T6I	FAC0202072	FAC0202074	FAC0202073	–	–	–	
3/4	1	3	1/4	T8I	FAC0202075	FAC0202077	FAC0202076	–	–	SG-7	

* indicates full carbide burrs

Note:

- Ask your local representative about our long shank program –Available in 4",5",6",7",8",9",10",11" & 12"
- All sizes available as a special in left hand cut
- Coarse cut burrs available on request

SH

Flame shape

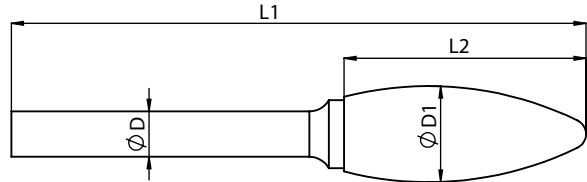

3 mm Shank

Head Diameter Ø D1	Head length L2	Overall Length L1	Shank Dia D	Tool No	Standard cut (Single cut)	Supreme cut (Double cut)	Deluxe cut (Diamond cut)	Aluma Cut	Coarse Cut	CTI Number
					EDP No.	EDP No.	EDP No.	EDP No.	EDP No.	
2.8	6.3	38	3	MF1*	FAC0200633	FAC0200634	FAC0200635	-	-	SH-41M
2.8	6.3	50	3	MF1L*	FAC0200636	FAC0200637	FAC0200638	-	-	SH-41ML2
6.3	16	42	3	MF2	FAC0201242	-	-	-	-	-

6 mm Shank

Head Diameter	Head length	Overall Length	Shank Dia	Tool No	Standard cut	Supreme cut	Deluxe cut	Aluma Cut	Coarse Cut	CTI Number
6.3	16	66	6	F1	FAC0200400	FAC0200401	FAC0200402	-	-	SH-1M
8	19	69	6	F2	FAC0200403	FAC0200404	FAC0200405	FAC0200409	-	SH-2M
9.5	25	75	6	F3	FAC0200410	FAC0200411	FAC0200413	FAC0200415	FAC0201423	SH-3M
12.7	32	82	6	F4	FAC0200416	FAC02006418	FAC0200420	FAC0200425	-	SH-5M
16	34	84	6	F5	FAC0200428	FAC0200430	FAC0201279	-	-	SH-6M
19	41	91	6	F6	FAC0200432	FAC0200434	FAC0200436	-	-	SH-7M

8 mm Shank

Head Diameter	Head length	Overall Length	Shank Dia	Tool No	Standard cut	Supreme cut	Deluxe cut	Aluma Cut	Coarse Cut	CTI Number
12.7	32	82	8	F4Z	FAC0200417	FAC0200419	-	-	-	-
16	34	84	8	F5Z	FAC0200429	FAC0200431	FAC0201917	-	-	SH-6M8
19	41	91	8	F6Z	FAC0200433	FAC0200435	FAC0200437	-	-	SH-7M8

1/8 inch Shank

Head Diameter	Head length	Overall Length	Shank Dia	Tool No	Standard cut	Supreme cut	Deluxe cut	Aluma Cut	Coarse Cut	CTI Number
1/8	1/4	1-1/2	1/8	MF11*	FAC0201981	FAC0201983	FAC0201982	-	-	SH-41

1/4 inch Shank

Head Diameter	Head length	Overall Length	Shank Dia	Tool No	Standard cut	Supreme cut	Deluxe cut	Aluma Cut	Coarse Cut	CTI Number
1/4	5/8	2-5/8	1/4	F11	FAC0201905	FAC0201907	FAC0201906	-	-	SH-1
5/16	3/4	2-3/4	1/4	F21	FAC0201908	FAC0201910	FAC0201909	-	-	SH-2
1/2	1-1/4	3-1/4	1/4	F41	FAC0201911	FAC0201913	FAC0201912	-	-	SH-5
5/8	1-5/8	3-5/8	1/4	F51	FAC0201914	FAC0201916	FAC0201915	-	-	SH-6
3/4	1-5/8	3-5/8	1/4	F61	FAC0201918	FAC0201920	FAC0201919	-	-	SH-7

* indicates full carbide burrs

Note:

- Ask your local representative about our long shank program –Available in 4",5",6",7",8",9",10",11" & 12"
- All sizes available as a special in left hand cut
- Coarse cut burrs available on request

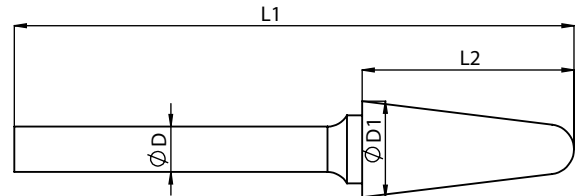
SL
Cone with radius end

3 mm Shank						Standard cut (Single cut)	Supreme cut (Double cut)	Deluxe cut (Diamond cut)	Aluma Cut	Coarse Cut	CTI Number
Head Diameter	Head length	Overall Length	Shank Dia	Angle Degree	Tool No	EDP No.	EDP No.	EDP No.	EDP No.	EDP No.	
ØD1	L2	L1	D								
3	8	38	3	10°	MK1*	FAC0200639	FAC0200641	FAC0200642	–	–	–
3	9.5	50	3	8°	MK1L*	FAC0200643	FAC0200644	FAC0200645	–	–	SL-41M
3	12.7	38	3	8°	MK3*	FAC0200650	FAC0200651	FAC0200652	–	–	SL-42M
6.3	12.7	38	3	10°	MK2	FAC0200646	FAC0200648	FAC0200649	–	–	SL-51M

6 mm Shank						Standard cut (Single cut)	Supreme cut (Double cut)	Deluxe cut (Diamond cut)	Aluma Cut	Coarse Cut	CTI Number
Head Diameter	Head length	Overall Length	Shank Dia	Angle Degree	Tool No	EDP No.	EDP No.	EDP No.	EDP No.	EDP No.	
6.3	16	66	6	14°	K0	FAC0200438	FAC0200439	FAC0201311	FAC0201344	–	SL-1M
9.5	19	69	6	16°	K1	FAC0200442	FAC0200443	FAC0200445	FAC0200453	–	–
12.7	19	69	6	24°	K2	FAC0200454	FAC0200456	FAC0200458	FAC0200467	–	–
16	33	83	6	17°	K3	FAC0200468	FAC0200470	FAC0200472	FAC0201238	–	–
12.5	30	82	6	17°	K4	FAC0200480	FAC0200481	FAC0200482	FAC0200485	–	–
19	42	92	6	14°	K5	FAC0200486	FAC0200488	FAC0200490	–	–	SL-7M
9.5	26	76	6	14°	K6	FAC0200494	FAC0200495	FAC0200496	FAC0201226	–	SL-3M
12.7	28	78	6	14°	K7	FAC0200501	FAC0200502	FAC0200504	–	–	SL-4M
16	33	83	6	14°	K8	FAC0200507	FAC0200509	FAC0200511	–	–	SL-5M
4	19	70	6	26°	GD-1	FAC0201141	–	–	–	–	–
3	8.5	68	6	10°	GD-2	FAC0201258	–	–	–	–	–
3	13	58	6	26°	GD-3	FAC0201259	–	–	–	–	–
3.8	19	69	6	35°	GD-4	FAC0201142	–	–	–	–	–

* indicates full carbide burrs

Note:

- Ask your local representative about our long shank program –Available in 4",5",6",7",8",9",10",11" & 12"
- All sizes available as a special in left hand cut
- Coarse cut burrs available on request

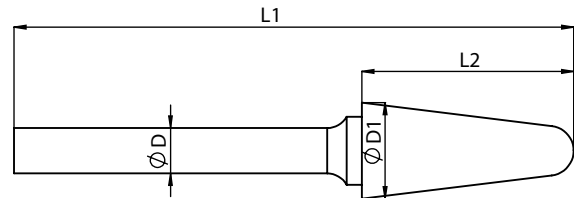
SL
Cone with radius end

8 mm Shank						Standard cut (Single cut)	Supreme cut (Double cut)	Deluxe cut (Diamond cut)	Aluma Cut	Coarse Cut	CTI Number
Head Diameter	Head length	Overall Length	Shank Dia	Angle Degree	Tool No	EDP No.	EDP No.	EDP No.	EDP No.	EDP No.	
ØD1	L2	L1	D								
12.7	19	69	8	24°	K2Z	FAC0200455	FAC0200457	FAC0200459	FAC0201166	–	–
16	33	83	8	17°	K3Z	FAC0200469	FAC0200471	FAC0200473	FAC0200479	–	–
16	33	83	8	14°	K8Z	FAC0200508	FAC0200510	FAC0200512	–	–	SL-5M8
19	42	92	8	14°	K5Z	FAC0200487	FAC0200489	FAC0200491	FAC0200493	–	SL-7M8

1/8 inch Shank						Standard cut (Single cut)	Supreme cut (Double cut)	Deluxe cut (Diamond cut)	Aluma Cut	Coarse Cut	CTI Number
Head Diameter	Head length	Overall Length	Shank Dia	Angle Degree	Tool No	EDP No.	EDP No.	EDP No.	EDP No.	EDP No.	
ØD1	L2	L1	D								
1/8	3/8	1-1/2	1/8	8°	MK1LI*	FAC0201984	FAC0201986	FAC0201985	–	–	SL-41
1/8	1/2	1-1/2	1/8	8°	MK3I*	FAC0201987	FAC0201989	FAC0201988	–	–	SL-42

1/4 inch Shank						Standard cut (Single cut)	Supreme cut (Double cut)	Deluxe cut (Diamond cut)	Aluma Cut	Coarse Cut	CTI Number
Head Diameter	Head length	Overall Length	Shank Dia	Angle Degree	Tool No	EDP No.	EDP No.	EDP No.	EDP No.	EDP No.	
ØD1	L2	L1	D								
1/4	5/8	2-5/8	1/4	14°	K0I	FAC0201921	FAC0201923	FAC0201922	–	–	SL-1
3/8	1-1/16	3-1/16	1/4	14°	K6I	FAC0201930	FAC0201932	FAC0201931	–	–	SL-3
1/2	1-1/8	3-1/8	1/4	14°	K7I	FAC0201933	FAC0201935	FAC0201934	–	–	SL-4
5/8	1-5/16	3-5/16	1/4	17°	K3I	FAC0201924	FAC0201926	FAC0201925	–	–	–
5/8	1-5/16	3-5/16	1/4	14°	K8I	FAC0201936	FAC0201938	FAC0201937	–	–	SL-5
3/4	1-1/2	3-1/2	1/4	14°	K5I	FAC0201927	FAC0201929	FAC0201928	–	–	SL-7

* indicates full carbide burrs

Note:

- Ask your local representative about our long shank program –Available in 4",5",6",7",8",9",10",11" & 12"
- All sizes available as a special in left hand cut
- Coarse cut burrs available on request

SM

Cone shape

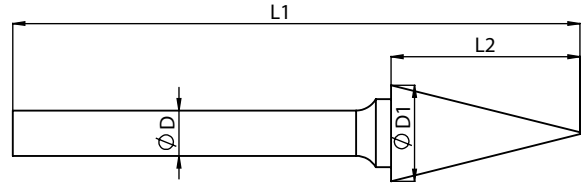

3 mm Shank						Standard cut (Single cut)	Supreme cut (Double cut)	Deluxe cut (Diamond cut)	Aluma Cut	Coarse Cut	CTI Number
Head Diameter	Head length	Overall Length	Shank Dia	Angle Degree	Tool No	EDP No.	EDP No.	EDP No.	EDP No.	EDP No.	
ØD1	L2	L1	D								
3	8	38	3	20°	MA1*	FAC0200513	FAC0200514	FAC0200515	–	–	–
6.3	10.5	36.5	3	30°	MA2	FAC0200518	FAC0200519	FAC0200520	–	–	SM-42M
3	11	38	3	14°	MA5*	FAC0200521	FAC0200522	FAC0200523	–	–	SM-43M
3	16	38	3	7°	MA6*	FAC0201255	FAC0201256	FAC0201257	–	–	SM-51M

6 mm Shank						Standard cut (Single cut)	Supreme cut (Double cut)	Deluxe cut (Diamond cut)	Aluma Cut	Coarse Cut	CTI Number
Head Diameter	Head length	Overall Length	Shank Dia	Angle Degree	Tool No	EDP No.	EDP No.	EDP No.	EDP No.	EDP No.	
ØD1	L2	L1	D								
6	19	50	6	17°	A1*	FAC0200001	FAC0200002	FAC0200003	FAC0201348	–	SM-2M
6	19	70	6	17°	A1	FAC0200004	FAC0201797	FAC0201790	–	–	SM-2M
9.5	20	70	6	24°	A2	FAC0200012	FAC0200014	FAC0200016	–	–	–
12.7	25	75	6	28°	A3	FAC0200022	FAC0200025	FAC0200027	FAC0201268	–	–
9.5	9.5	60	6	90°	A4	FAC0200036	FAC0200037	FAC0200038	–	–	SK-3M
16	13	63	6	90°	A5	FAC0200039	FAC0200040	FAC0200041	FAC0201353	–	SK-6M
16	16	66	6	60°	A6	FAC0200044	FAC0200046	FAC0200047	–	–	SJ-6M
10	18	68	6	28°	A7	FAC0200050	FAC0200051	FAC0200052	–	–	SM-4M
8	18	68	6	24°	A8	FAC0200053	FAC0200054	FAC0200055	–	–	–
16	25	75	6	31°	A9	FAC0200056	FAC0200058	FAC0200060	–	–	SM-6M
6.2	25	75	6	10°	A10	FAC0200062	FAC0200063	FAC0200064	–	–	SM-3M
9.5	15	65	6	28°	A11	FAC0200065	FAC0200066	FAC0200067	–	–	–
12.7	22	72	6	28°	A12	FAC0200068	FAC0200069	FAC0200070	–	–	SM-5M
6.3	12.7	63	6	22°	A13	FAC0200071	FAC0200072	FAC0200073	–	–	SM-1M

* indicates full carbide burrs

Note:

- Ask your local representative about our long shank program –Available in 4",5",6",7",8",9"10",11"& 12"
- All sizes available as a special in left hand cut
- Coarse cut burrs available on request

SM

Cone shape

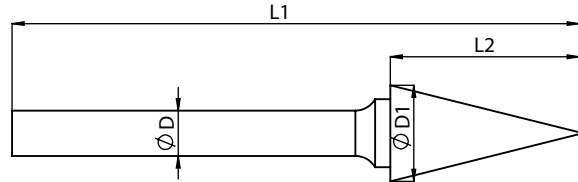

8 mm Shank

Head Diameter	Head length	Overall Length	Shank Dia	Angle Degree	Tool No	Standard cut (Single cut)	Supreme cut (Double cut)	Deluxe cut (Diamond cut)	Aluma Cut	Coarse Cut	CTI Number
Ø D1	L2	L1	D			EDP No.	EDP No.	EDP No.	EDP No.	EDP No.	
9.5	20	70	8	24°	A2Z	FAC0201798	FAC0200015	FAC0201799	-	-	-
12.7	25	75	8	28°	A3Z	FAC0201800	FAC0200026	FAC0201801	-	-	-
16	16	66	8	60°	A6Z	FAC0200045	FAC0201803	FAC0201802	-	-	-
16	25	75	8	31°	A9Z	FAC0200057	FAC0200059	FAC0200061	-	-	SM-6M8

1/8 inch Shank

1/8	11/32	1-1/2	1/8	20°	MA1*	FAC0201939	FAC0201941	FAC0201940	-	-	SM-41
1/8	7/16	1-1/2	1/8	14°	MA5*	FAC0201942	FAC0201944	FAC0201943	-	-	SM-42
1/8	5/8	1-1/2	1/8	7°	MA6*	FAC0201945	FAC0201947	FAC0201946	-	-	SM-43

1/4 inch Shank

1/4	1/2	2-1/2	1/4	22°	A13I	-	FAC0201792	FAC0201791	-	-	SM-1
1/4	3/4	2-3/4	1/4	17°	A1I	FAC0201794	FAC0201796	FAC0201795	-	-	SM-2
1/4	1.00	3.00	1/4	10°	A10I	FAC0201781	FAC0201783	FAC0201782	-	-	SM-3
3/8	5/8	2-5/8	1/4	28°	A11I	FAC0201784	FAC0201786	FAC0201785	-	-	SM-4
1/2	7/8	2-7/8	1/4	28°	A12I	FAC0201787	FAC0201789	FAC0201788	-	-	SM-5
5/8	1.00	3.00	1/4	31°	A9I	FAC0201804	FAC0201806	FAC0201805	-	-	SM-6

* indicates full carbide burrs

Note:

- Ask your local representative about our long shank program –Available in 4",5",6",7",8",9",10",11"& 12"
- All sizes available as a special in left hand cut
- Coarse cut burrs available on request

SN
Inverted cone shape

3 mm Shank						Standard cut (Single cut)	Supreme cut (Double cut)	Deluxe cut (Diamond cut)	CTI Number
Head Diameter	Head length	Overall Length	Shank Dia	Angle Degree	Tool No	EDP No.	EDP No.	EDP No.	
Ø D1	L2	L1	D						
2.8	8.5	38	3	10°	MA3*	FAC0200530	FAC0200531	FAC0200532	SN-42M
6.3	8	38	3	15°	MA4*	FAC0200533	FAC0200535	FAC0200536	-

6 mm Shank						Standard cut (Single cut)	Supreme cut (Double cut)	Deluxe cut (Diamond cut)	CTI Number
Head Diameter	Head length	Overall Length	Shank Dia	Angle Degree	Tool No	EDP No.	EDP No.	EDP No.	
6.3	8	58	-	10	N1	FAC0200538	FAC0200539	FAC0202008	SN-1M
10	10	58	-		N2	-	FAC0202240	FAC0202241	SN-2M
12.7	12.7	62	-	16	N4	FAC0200540	FAC0200541	FAC0202145	SN-4M
16	16	62	-		N3	-	FAC0202243	-	-

1/4 inch Shank						Standard cut (Single cut)	Supreme cut (Double cut)	Deluxe cut (Diamond cut)	CTI Number
Head Diameter	Head length	Overall Length	Shank Dia	Angle Degree	Tool No	EDP No.	EDP No.	EDP No.	
1/4	5/16	2-5/16	1/4	10°	N1I	FAC0202009	FAC0202011	FAC0202010	SN-1
1/2	1/2	2-1/2	1/4	16°	N4I	FAC0202012	FAC0202014	FAC0202013	SN-4

* indicates full carbide burrs

Note:

- Ask your local representative about our long shank program –Available in 4",5",6",7",8",9"10",11" & 12"
- All sizes available as a special in left hand cut
- Coarse cut burrs available on request

RIM

Rim shape

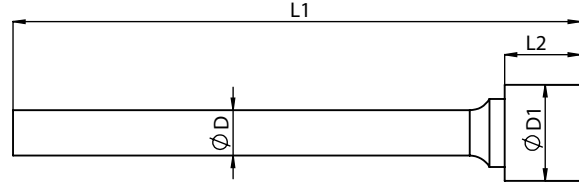

6 mm Shank				Tool No	Standard cut (Single cut)	Supreme cut (Double cut)	Deluxe cut (Diamond cut)	Aluma Cut	CTI Number
Head Diameter	Head length	Overall Length	Shank Dia		EDP No.	EDP No.	EDP No.	EDP No.	
ØD1	L2	L1	D						
9.5	2	52	6	R1	FAC0200786	FAC0200787	FAC0200788	-	-
12.7	10	60	6	R3	FAC0200796	FAC0200797	FAC0200798	FAC0200800	-
15	5	54	6	R4	FAC0200801	FAC0200802	FAC0200803	-	-
19.1	6	56	6	R2	FAC0201282	FAC0200790	FAC0200791	FAC0200795	-

* indicates full carbide burrs

Note:

- Ask your local representative about our long shank program –Available in 4",5",6",7",8",9",10",11"& 12"
- All sizes available as a special in left hand cut
- Coarse cut burrs available on request

Burr sets



BURR SET - 6 MM SHANK

BS1* - C8, B6, S4, TB3, T3, F4, K2, A3

(Dia 12.7 > Cylindrical, Cylindrical - Radius End, Ball, Tree Radius end, Tree, Flame, Cone-Radius End, Cone Shapes)

EDP No.	Description
FAC0201086	TCRB SET BS1 (STANDARD CUT)
FAC0201192	TCRB SET BS1 (DELUX CUT)
FAC0201087	TCRB SET BS1 (SUPREME)

BS2* - C4, B3, S3, TB2, T2, F3, K6, A11

(Dia 9.5 > Cylindrical, Cylindrical - Radius End, Ball, Tree Radius end, Tree, Flame, Cone-Radius End, Cone Shapes)

EDP No.	Description
FAC0201088	TCRB SET BS2 (STANDARD CUT)
FAC0201236	TCRB SET BS2 (DELUXE CUT)
FAC0201089	TCRB SET BS2 (SUPREME CUT)

BURR SET - 3 MM SHANK

MINIBS1* - MC1, MC5, MBO, MB1, MSO, MO1, MTB2, MT5, MF1, MK3, MA5, MA3

(Dia 3.0 > Cylindrical, Cylindrical - Radius End, Ball, Oval, Tree Radius end, Tree, Flame, Cone-Radius End, Cone, Inverted Cone Shapes)

EDP No.	Description
FAC0201090	TCRB SET MINIBS1 (STANDARD CUT)
FAC0201091	TCRB SET MINIBS1 (SUPREME CUT)

* While ordering please specify the fluting style - Standard Cut / Supreme Cut (Double Cut).

FL

Flexible carbide burrs

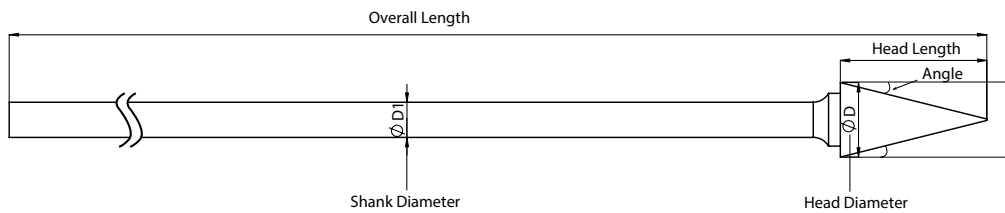
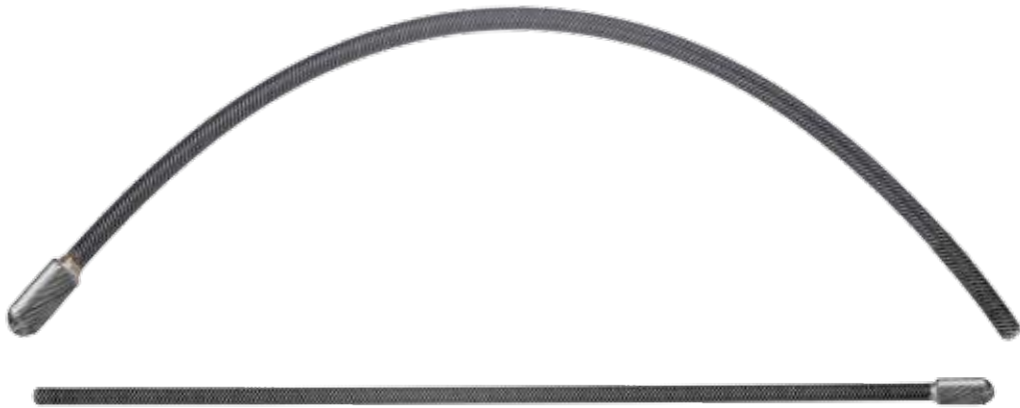

CARBIDE BURRS



	Head Diameter	Head length	Overall Length	Shank Dia	Tool No	Standard cut	Supreme cut	Deluxe cut
	Ø D1	L2	L1	D		EDP No.	EDP No.	EDP No.
6 mm Shank  CYLINDRICAL WITHOUT END CUT	8.00	19.00	150.00	6.00	C3L2 FLEXI BURR	FAC0203021	FAC0203022	FAC0203023
	9.50	19.00	150.00	6.00	C4L2 FLEXI BURR	FAC0203024	FAC0203025	FAC0203026
	12.70	19.00	150.00	6.00	C5L2 FLEXI BURR	FAC0203027	FAC0203028	FAC0203029
 CYLINDRICAL WITH END CUT	8.00	19.00	150.00	6.00	CE3L2 FLEXI BURR	FAC0203030	FAC0203031	FAC0203032
	9.50	19.00	150.00	6.00	CE4L2 FLEXI BURR	FAC0203033	FAC0203034	FAC0203035
	12.70	19.00	150.00	6.00	CE5L2 FLEXI BURR	FAC0203036	FAC0203037	FAC0203038
 CYLINDRICAL WITH RADIUS END	8.00	19.00	150.00	6.00	B2L2 FLEXI BURR	FAC0203016	FAC0203039	FAC0203040
	9.50	19.00	150.00	6.00	B3L2 FLEXI BURR	FAC0203017	FAC0203041	FAC0203042
	12.70	19.00	150.00	6.00	B4L2 FLEXI BURR	FAC0203018	FAC0203043	FAC0203044

** Also available in Shank Length 8", 10", 12"

FL

Flexible carbide burrs

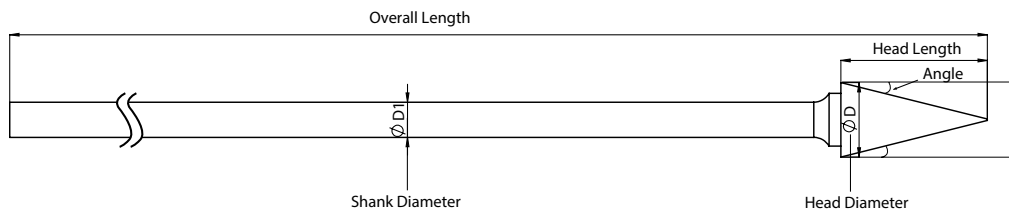
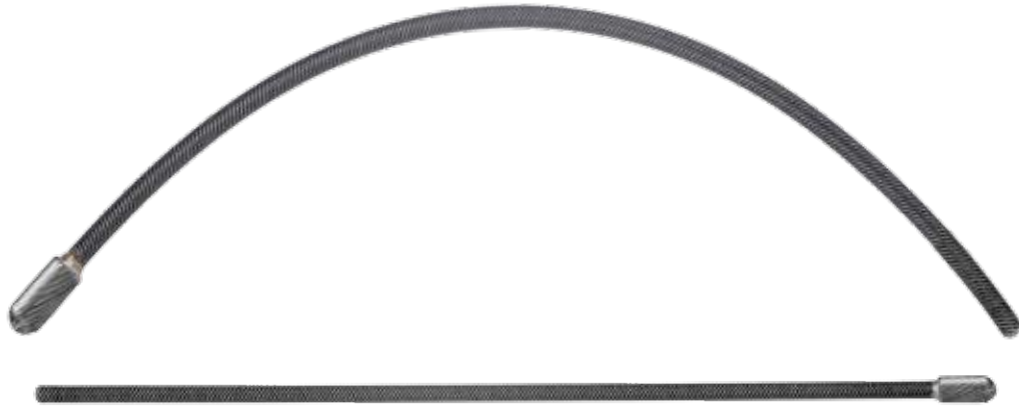

	Head Diameter	Head length	Overall Length	Shank Dia	Tool No	Standard cut	Supreme cut	Deluxe cut
	Ø D1	L2	L1	D		EDP No.	EDP No.	EDP No.
6 mm Shank								
 BALL SHAPE	8.00	6.40	150.00	6.00	S2L2 FLEXI BURR	FAC0203045	FAC0203046	FAC0203047
	9.50	8.00	150.00	6.00	S3L2 FLEXI BURR	FAC0203048	FAC0203049	FAC0203050
	12.70	11.00	150.00	6.00	S4L2 FLEXI BURR	FAC0203051	FAC0203052	FAC0203053
 TREE SHAPE WITH RADIUS END	9.50	19.00	150.00	6.00	TB2L2 FLEXI BURR	FAC0203060	FAC0203061	FAC0203062
	12.70	25.00	150.00	6.00	TB3L2 FLEXI BURR	FAC0203063	FAC0203064	FAC0203065
 TREE SHAPE WITH POINT END	9.50	19.00	150.00	6.00	T2L2 FLEXI BURR	FAC0203066	FAC0203067	FAC0203068
	12.70	25.00	150.00	6.00	T3L2 FLEXI BURR	FAC0203069	FAC0203070	FAC0203071

CARBIDE BURRS

** Also available in Shank Length 8", 10", 12"

Investment Casting units



Fettling Shops



Precision Casting Shop



Welding Shops



Construction



Forging Units



Automotive



Heavy Engineering

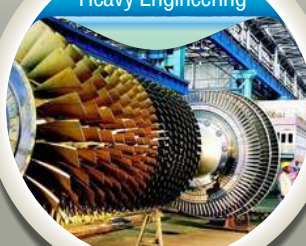

Post Processing - Deburring



Optimal burr

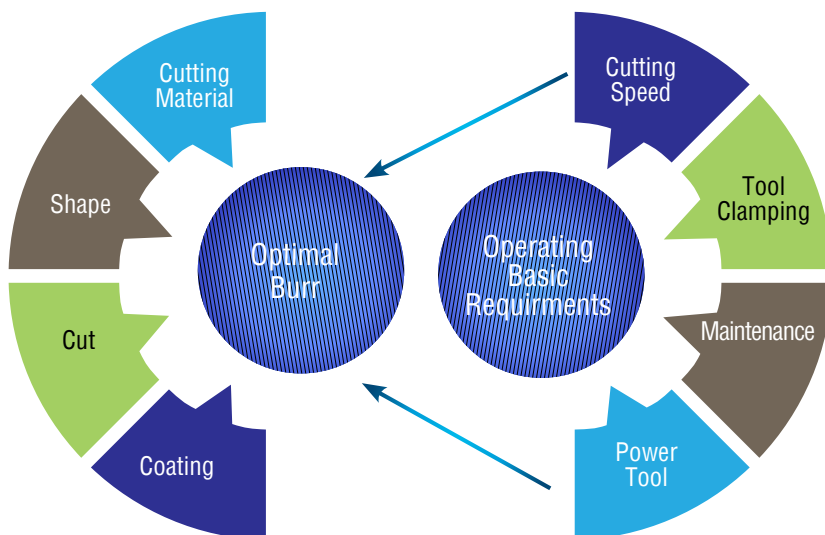

Cutting material

Totem burrs are manufactured using the best quality of raw material. The EN-24 shanks used are precision turned and ground to ensure the least possible run out.

Coating

Our TiN and TiCN high performance burrs are offered in extreme conditions to

- a) Increase tool Life
- b) Reduce cutting forces
- c) Improve machinability
- d) Better chip evacuation

Carbide burrs nomenclature

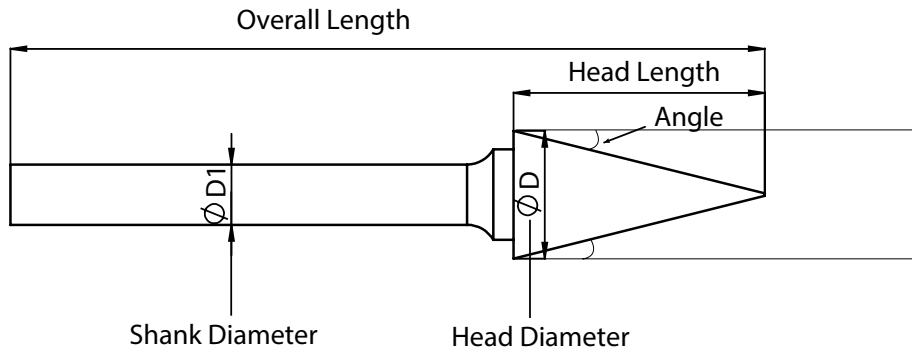

TYPE OF CUTS



Standard Cut (Single Cut):

This flute structure is designed for superior material removal and general purpose application. These can be used on Steel, Steel alloys, Cast Iron, Stainless Steel, Hard Bronze and Copper. Produces longer chips.



Supreme Cut (Double Cut / Cross Cut):

This burr allows for efficient stock removal in the harder materials. Its design reduces tool chatter and breaks the chips into granular shapes. These smaller chips also help to eliminate loading on the flutes. This design helps to have better control on the burr and grinder.



Deluxe Cut (Diamond Cut):

This design of tool is like triangular style of point, which produces extremely small chips (powder like chips). The cut eliminates pulling action of the main cut, and offers the operator good control over the tool and produces excellent finish. Effective in heat treated Steels and Tough alloy steels.



Aluma Cut (NF):

Designed for rapid stock removal on Non-ferrous materials. Recommended to work on Aluminium, Zinc alloy, Hand rubber and Wood.



Coarse Cut

Designed for hard aluminum alloys with an Si-content greater than 12% and non-ferrous metals.



Typical Shapes

SB/ZYAS Series



SA/ZYA Series

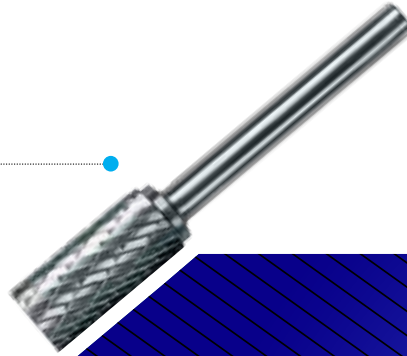

SH Series

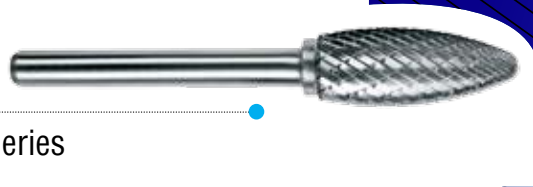

SC/WRC Series

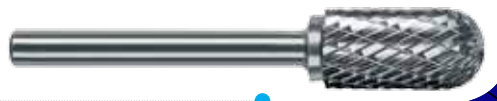

RIM Series

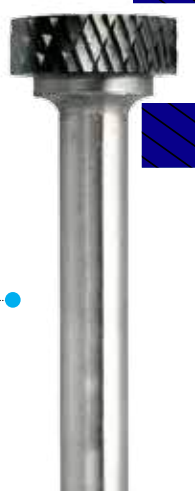

SG/SPG Series





Typical Shapes

SD/KUD Series



SE/TRE Series



SF/RBF Series



Long Length Special



SL/KEL Series



SN Series

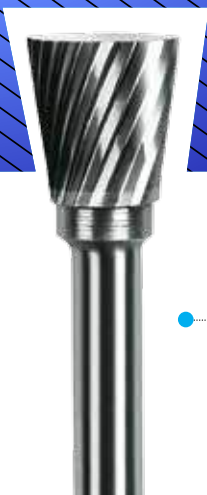

SM/SKM Series



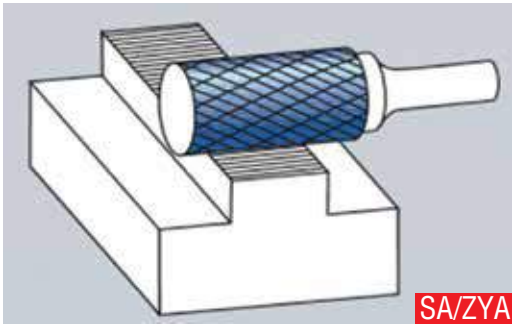

SA/ZYA

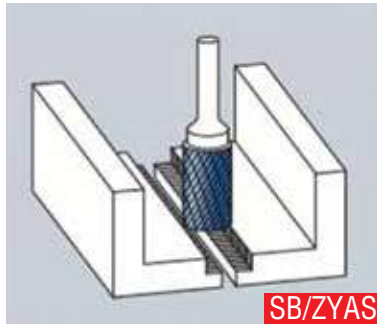

SB/ZYAS

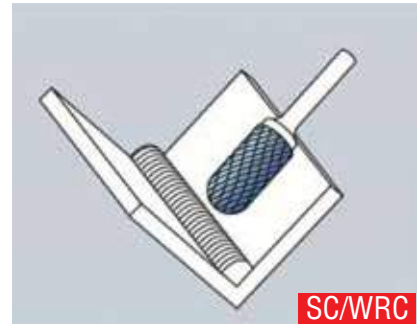

SC/WRC



SD/KUD

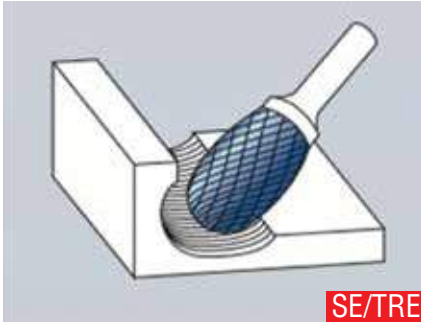

SE/TRE

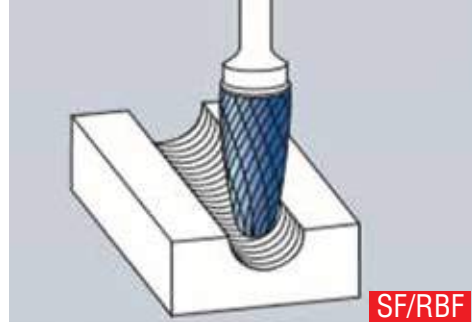

SF/RBF



SG/SPG



SH

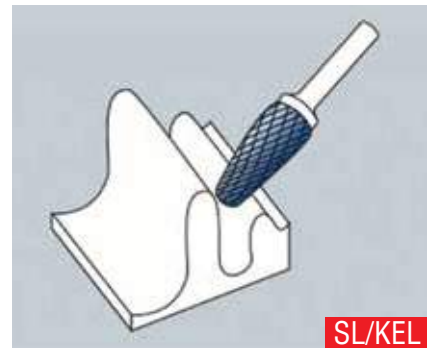

SL/KEL

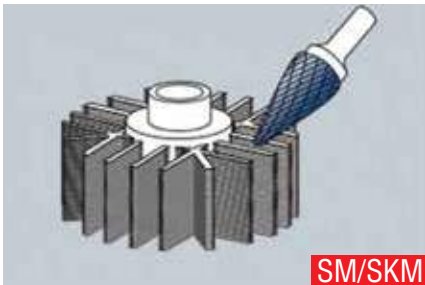

SM/SKM

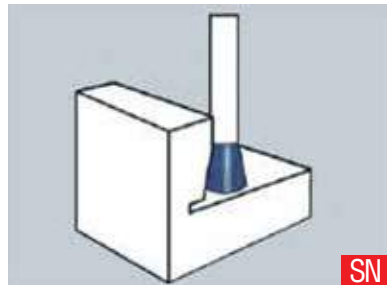

SN

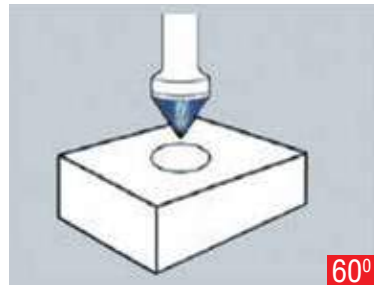

60°



90°

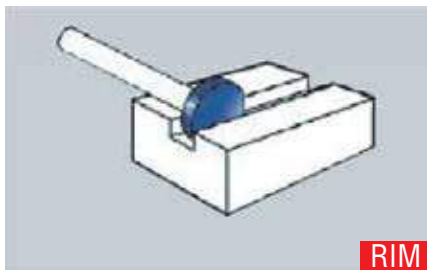

RIM

Material application

Material Groups			Application	Cut Type				
				Standard	Supreme	Deluxe	Aluma	Coarse
Steel and Steel castings	Non Hardened, non heat treated steels upto 1200 N/mm ² (<35 HRC)	Constructional steels Carbon steels Tool steels	Coarse machining = high stock removal	X	X			
		Non-alloyed steels Case-hardened steels Steel castings	Fine machining - eg: deburring			X		
	Hardened, heat treated steels exceeding 1200 N/mm ² (>35 HRC)	Tool steels Tempering steels	Coarse machining = high stock removal	X	X			
		Alloyed steels Steel castings	Fine machining - eg: deburring			X		
High-grade steels	Stainless steels	Austenitic and ferritic high-grade steels	Coarse machining = high stock removal					X
			Fine machining - eg: deburring			X		
Non - ferrous metals	Soft non-ferrous metals	Aluminium alloys Brass Copper Zinc	Coarse machining = high stock removal				X	
			Fine machining - eg: deburring				X	
	Hard non-ferrous metals	Bronze Titanium / titanium alloys Very hard aluminium alloys (high Si content)	Coarse machining = high stock removal	X	X			
			Fine machining - eg: deburring			X		
	Heat resisting alloys	Nickel based alloys NiCo alloys (aircraft engine and turbine construction)	Coarse machining = high stock removal	X	X			
			Fine machining - eg: deburring			X		
Cast Iron		Grey Cast Iron Spheroidal Graphite cast iron	Coarse machining = high stock removal	X	X			
			Fine machining - eg: deburring			X		
Plastics / Other materials		Fibre Reinforced plastics Thermoplastics hard rubber	Coarse machining = high stock removal				X	
			Fine machining - eg: deburring				X	



Cutting parameters

Material	3mm	6mm	8mm	10mm	12mm	16mm	20mm	25mm
Steel	60-90	30-45	25-35	20-30	15-25	10-18	10-14	8-10
Hardened / Tool Steel	30-40	15-20	10-15	10-15	8-10	5-8	4-7	3-5
Stainless Steel	30-50	15-25	12-20	10-15	9-12	7-10	5-7	4-5
Nickel / Titanium	30-40	15-20	10-15	10-15	8-10	5-8	4-7	3-5
Cast Iron	60-90	30-45	25-35	20-30	15-20	10-18	10-14	8-10
Aluminium / Plastics	30-90	15-60	12-50	10-50	8-35	6-30	5-20	4-15
Brass	40-50	20-30	15-20	13-17	10-15	8-12	6-8	5-6
Copper	30-90	15-60	12-50	10-50	8-35	6-30	5-20	4-15
Zinc	60-90	30-45	25-35	20-30	15-25	10-18	10-14	8-10

The table lists recommended rotational speeds (RPM) as a function of burr diameter.

SAFETY NOTE:-

Tools with long shanks must be placed on the workpiece, or inserted into the bore or groove, before the power source is switched on. For safety reasons we urge you to reduce idling speeds (RPM) by up to one-third from the values stated.

Recommendations for use:

TOTEM Tungsten Carbide Burrs are designed for machining materials of virtually any strength; the superior performance reflects an optimum combination of key parameters such as shape, number of flutes, spiral angle, rake angle and concentricity. The precise concentricity of TOTEM tungsten carbide burrs

- Ensures an improved protection of operator safety and health
- Reduces power tool wear
- Provides smooth operating behaviour
- Prevents chatter marks

An optimum power output and RPM of the power source (air-powered or electric machine, flexible shaft system) are necessary conditions for an economically efficient use of tungsten carbide burrs. We therefore recommend you to observe the following rules:

- Work with maximum RPM. Do not use speeds below 3000 RPM except in special cases (eg: on stationery machines or when countersinking with fully immersed burr).
- Chucks and collets must be absolutely concentric to avoid chipping. Tool runout and chatter will result in premature wear.
- Work with significantly reduced RPM on poorly heat conducting materials (eg: stainless steel, titanium alloys, etc.) to prevent tool damage. Avoid the typical blue Discoloration of the shank and the tool.
- In light cutting applications (deburring, chamfering, light surface work) the tool speed may be increased up to twice indicated rate.
- When machining very sticky materials, the use of a suitable lubricant (grease, kerosene, chalk or similar) is recommended to prevent loading.